



311400

DX 450

| | |
|-----------------------------------|---------|
| Bedienungsanleitung | 2–11 |
| Operating instructions | 12–21 |
| Mode d'emploi | 22–31 |
| Istruzioni d'uso | 32–41 |
| Gebbruiksaanwijzing | 42–51 |
| Manual de instrucciones | 52–61 |
| Manual de instruções | 62–71 |
| Οδηγίες χρήσεως | 72–81 |
| Инструкция по эксплуатации | 82–91 |
| Kullanım kılavuzu | 92–101 |
| 操作説明書 | 102–111 |
| 취급설명서 | 112–122 |

HILTI



Safety precautions

Failure to follow these precautions may result in personal injury.

Only use Hilti cartridges or cartridges of equivalent quality

The use of cartridges of inferior quality in Hilti tools may lead to build-up of unburned powder, which may explode and cause severe injuries to operators and bystanders. At a minimum, cartridges must either:

- a) **Be confirmed by their supplier to have been successfully tested in accordance with EU standard EN 16264**

NOTE:

- All Hilti cartridges for powder-actuated tools have been tested successfully in accordance with EN 16264.
- The tests defined in the EN 16264 standard are system tests carried out by the certification authority using specific combinations of cartridges and tools. The tool designation, the name of the certification authority and the system test number are printed on the cartridge packaging.

or

- b) **Carry the CE conformity mark (mandatory in the EU as of July 2013).**

See packaging sample at: www.hilti.com/dx-cartridges

Warnings

1. Never attempt to use the tool without first having received proper instruction on its use and associated safety precautions. Contact your local Hilti sales representative for assistance.
2. Always use the tool strictly in accordance with the operating instructions. The operating instructions should always be kept with the tool.
3. Never point the tool at yourself or any bystander.
4. Never press the muzzle of the tool against your hand or other part of your body.
5. The operator, and any other persons in the immediate vicinity, must wear suitable protective goggles, a helmet and ear protection while the tool is in use.

Safety precautions

6. Operate the tool only in well-ventilated working areas.
7. Use the stabiliser/guard whenever possible.
8. Never leave a loaded tool unattended. Always unload the tool before beginning cleaning and servicing, before putting the tool away at the end of the day, before work breaks, and before changing parts.
9. Always check that the tool is undamaged and fully functional before it is used. Never attempt to use an incomplete or malfunctioning tool.
10. Keep the arms flexed when the tool is fired (do not straighten the arms). Stop working with the tool if you feel unwell.
11. Avoid unfavorable body positions. Work from a secure stance and stay in balance at all times.
12. Always hold the tool perpendicular to the working surface and material in which the fastener is to be driven.

13. To avoid the risk of injury, use only original Hilti fasteners, cartridges, accessories and spare parts or those of equivalent quality.
14. Never attempt to pry a cartridge from magazine strip or tool.
15. If a cartridge misfires or fails to ignite, proceed as follows:
 - Keep the tool against the working surface for 30 seconds.
 - If the cartridge still fails to fire, withdraw the tool from the working surface, taking care that it is not pointed towards your body or bystanders.
 - Cycle the tool so that the magazine strip is transported to the next cartridge. Use up the remaining cartridges on the strip. Remove the used cartridge strip and dispose of it in such a way that it can be neither reused nor misused.
16. Never attempt to drive a fastener in an existing hole, except where recommended by Hilti, e. g. when using the DX-Kwik system.
17. Do not make fastenings in an explosive or flammable atmosphere, except when tool is approved for such use.
18. Application recommendations must always be observed.
19. Before using the tool, make sure that no one is standing behind or below the point where fasteners are to be driven.
20. Do not disassemble the tool while it is hot.
21. Never exceed the recommended maximum fastener driving rate (number of fastenings per hour). The tool may otherwise overheat.
22. Always keep the tool and cartridges in a closed container in a safe place when not in use.
23. Unused cartridges and tools not presently in use must be stored in a place where they are not exposed to humidity or excessive heat.
24. The tool should be transported and stored in a toolbox that can be locked or secured to prevent use by unauthorized persons.
25. Do not attempt to drive fasteners into unsuitable materials: Materials that are too hard, e.g. welded steel and cast iron. Materials that are too soft, e.g. wood and drywall panel (gypsum board). Materials that are too brittle, e.g. glass and ceramic tiles. Driving a fastener into these materials may cause the fastener to break, shatter or to be driven right through.
26. Never attempt to drive fasteners into materials such as glass, marble, plastic, bronze, brass, copper, rock, insulation material, hollow brick, ceramic brick, thin sheet metal (< 4 mm), cast iron or cellular concrete.
27. Check the tool and its accessories for any damage. Guards, safety devices and any slightly worn parts must be checked carefully to ensure that they function faultlessly and as intended. Check that moving parts function correctly without sticking and that no parts are damaged. All parts must be fitted correctly and fulfill all conditions necessary for correct operation of the tool. Damaged guards, safety devices and other parts must be repaired or replaced properly at a Hilti service center unless otherwise indicated in the operating instructions.

General notes

28. Never attempt to redrive the same fastener.
29. The applicable national regulations must always be observed, particularly those relating to accident prevention.

DX450 fastening tool

Through-shot and ricochet prevention

The piston principle employed results in low fastener velocity and dissipation of excess driving power.

The drop-firing safety device

The drop-firing safety device is the result of coupling the firing mechanism with the cocking movement. This is designed to help prevent the Hilti DX tool from firing when it is dropped onto a hard surface, no matter at which angle the impact occurs.

Contact pressure safety device

This safety device prevents the loaded tool from being fired unless it is pressed against a firm working surface. The tool can only be fired after it has been cocked by pressing it against the working surface, overcoming a cocking force of at least 90 N and cocking movement of 18 mm.

Personal protective equipment



The user and any other persons in the vicinity must wear suitable eye protection, a hard hat and ear protection while the tool is in use or when remedying a problem with the tool.



Technical data

| | |
|--------------|-----------------------------------|
| Weight: | 3.2 kg |
| Tool length: | 350 mm |
| Nail length: | max. 72 mm |
| Cartridges: | 6.8/11M black, red, yellow, green |

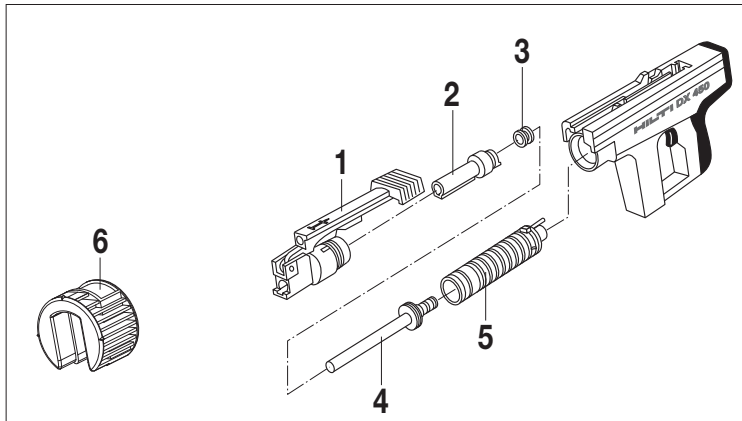

Parts of the tool (standard version)

Designation

- ① Baseplate 45/S1
- ② Fastener guide 45/F1
- ③ Stop ring
- ④ Piston 45/NK
- ⑤ Piston guide
- ⑥ Stabilizer

Technical description

The Hilti DX450 is a powder-actuated tool designed for driving nails (see Fastening Technology Manual). The DX450 employs the well-proven piston principle, thus providing an optimum of working and fastening safety. As with all powder-actuated tools, the tool, magazine, fastener programme and cartridge programme form a «technical unit». This means that troublefree fastening with this system can only be assured if the fasteners and cartridges specially manufactured for it, or products of equivalent quality, are used. The fastening and application recommendations given by Hilti are only applicable if this condition is observed. The recommended maximum fastening rate is 500 fastenings per hour.

The fastening and application recommendations given by Hilti are only applicable if these conditions are observed.

Spare parts

The user/owner of the tool may replace the parts listed on page 12 (parts 1–5). Only the procedures described in these operating instructions (disassembly/assembly/operation/care and maintenance) should be used. Any other unauthorised manipulations may negatively affect functional safety of the tool.

Disassembly



1 Pivot cocking lever forward. Press forward connector in housing while lifting catch (link) to disengage.



2 Screw off baseplate.

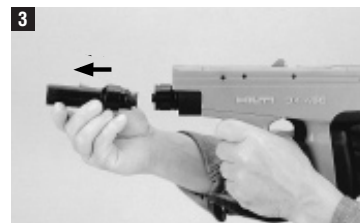

3 Pull fastener guide off piston guide.

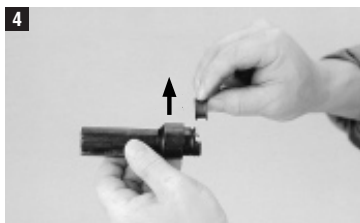

4 Pull stop ring off fastener guide to one side.



5 Let piston guide slide out of housing.



6 Push piston out of piston guide using supplied rod.

Assembly

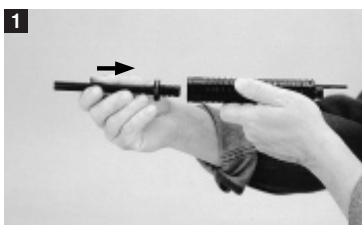

Insert piston in its guide.



Insert piston guide in housing. (Slot in piston guide must align with silencer).



Press stop ring on fastener guide.

Insert fastener guide in piston guide.



Slide over baseplate. (Recess in baseplate must align with raised part of fastener guide.)

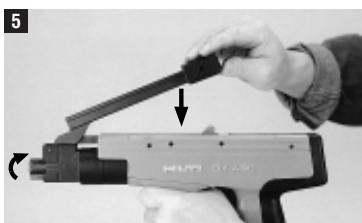

Screw on baseplate as far as it goes, then screw back until it snaps in place. Swing over cocking lever to resting position. Connector and link will automatically latch again.

Operation



1 Hold tool with muzzle upwards. Insert fastener point first in cocking lever and let it slide down.



2 Pull firmly to release and swing over cocking lever till aligned with muzzle.

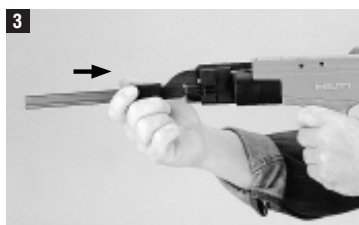

3 Pull back loading grip on cocking lever as far as it goes. This positions fastener correctly in guide. Return grip and pivot cocking lever back to original position.



4 Insert cartridge magazine in base of grip.
Caution!
Do not insert magazine until fastener has been loaded.
If this sequence is not observed the first cartridge will be missed (not fired).



5 Check power regulation.
Indicator in rear position means max. power.

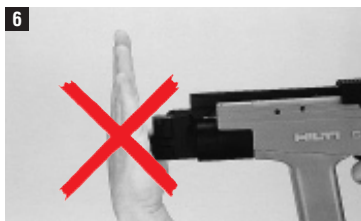

6 **Caution!**
Never use the palm of the hand to push back the fastener guide and never attempt to pull it back by way of the nail / washer. This could present a risk of injury to the operator!

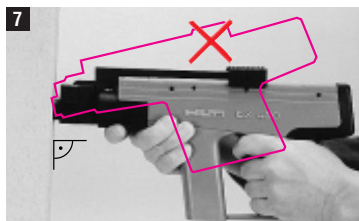

7 Hold the tool at right angles to the material in which the fastener is to be driven, press the muzzle against the surface and pull the trigger.

Select a cartridge power level and power setting to suit the application.
If you cannot estimate this on the basis of previous experience, always begin with the lowest power. Select a cartridge of the lowest power level (color code) and turn the power regulating wheel to 1.

Cleaning and servicing

The surfaces should be cleaned with the supplied brushes.



1
Inside housing



2
Inside of cartridge chamber



3
Inside of piston guide



4
Outside of piston guide



5
Piston

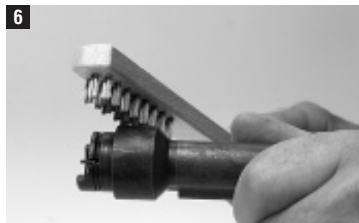

6
Outside of fastener guide



7
Inside of fastener guide



8
Outside of baseplate



9
Inside of baseplate

Before reassembling, lubricate all parts sparingly with Hilti spray.

The tool should be cleaned once a week or after a large number of fasteners have been driven (approx. 2500 fasteners).

CAUTION while cleaning the tool:

- Never use grease for maintenance/lubrication of tool parts. This may strongly affect the functionality of the tool. Use only Hilti spray or such of equivalent quality.
- Dirt from DX tool contains substances that could be endangering your health.
 - Do not breath in the dust from cleaning
 - Keep dust away from food
 - Wash your hands after cleaning the tool

Malfunctioning and remedies

| Malfunction | Remedies |
|---|---|
| Misfire: | See "Cartridge misfire". (See paragraph 14 on page 13). |
| Repeated misfires: | Service the tool |
| Very significant drop in driving power: | Service the tool |
| Widely varying depth of penetration: | Cycle the tool fully, i.e. pull out the assembly all the way. It may be necessary to lubricate the baseplate and piston guide slightly using Hilti spray. |
| Stiff cycling action: | Use Hilti spray to lubricate the piston guide and baseplate. |

Replacing a deformed stop ring

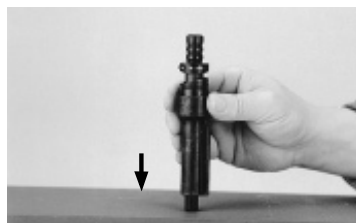

A deformed stop ring may jam on the piston. The fastener guide and piston bind together and have to be separated.

Procedure

Strike protruding piston sharply against a hard surface. This will separate piston and stop ring. Remove piston completely from fastener guide. Pull stop ring off fastener guide to one side and press in a new one.

Versions / spare parts

Versions

DX 450 standard

| Ordering designation | Item no. |
|-----------------------------------|---------------|
| Basic unit | 724 |
| Piston guide 125 assy. | 728 |
| 45/NK piston | 409299 |
| 45/F1 fastener guide assy. | 729 |
| 45/S1 base plate assy. | 731 |

DX 450 facade

| Ordering designation | Item no. |
|-----------------------------------|---------------|
| Basic unit | 724 |
| Piston guide 125 assy. | 728 |
| 45/DNI-B piston | 409301 |
| 45/F5 fastener guide assy. | 770 |
| 45/S5 base plate assy. | 737 |

DX 450-SCT (Sprayed concrete testing)

| Ordering designation | Item no. |
|------------------------------------|--------------|
| Basic unit | 724 |
| L140 piston guide 125 assy. | 787 |
| 45/M6-8L piston | 88058 |
| 45/FL1 fastener guide assy. | 730 |
| 45/SL1 base plate assy. | 732 |

Spare parts (all versions)

| Ordering designation | Item no. |
|----------------------|---------------|
| Stop ring | 855 |
| Stabilizer | 409283 |

The following items are supplied with the tool:
Cleaning set, Hilti lubricant spray, operating instructions

Printed: 24.03.2014 | Doc-Nr: PUB / 5125252 / 000 / 02

Threaded studs and nails

Fasteners

DX 450 standard

| | |
|---|---------------------------------------|
| NK, ENK, NKS...S12 | |
| Knob head style nails | with 12 mm steel washer |
| X-CR...S / D12 | |
| Stainless steel nails | with 12 mm steel washer(s) |
| (E)M6 / (E)M8 / (E)M10...S / D / P12 | |
| Threaded studs | with 12 mm steel or plastic washer(s) |
| X-CR M...P12 | |
| Stainless steel threaded studs | with 12 mm plastic washer |

DX 450 facade

| Ordering designation | Item no. |
|----------------------|---------------|
| X-CR 14 P8 | 306701 |
| X-CR 16 P8 | 247356 |

DX 450-SCT (Sprayed concrete testing)

| Ordering designation | Item no. |
|----------------------|---------------|
| X-M6-8-52 D12 | 306050 |
| X-M6-8-72 D12 | 306051 |
| X-M6-8-95 D12 | 306052 |

Cartridges

| Ordering designation | Item no. | Colour code | Power level |
|-----------------------|--------------|-------------|-------------|
| 6,8/11M gren | 50351 | Gren | light |
| 6,8/11M yellow | 50352 | Yellow | medium |
| 6,8/11M red | 50353 | Red | heavy |
| 6,8/11M black | 50354 | Black | magnum |

Disposal



Most of the materials from which Hilti power actuated tools are manufactured can be recycled. The materials must be correctly separated before they can be recycled. In many countries, Hilti has already made arrangements for taking back your old powder actuated tools for recycling. Please ask your Hilti customer service department or Hilti sales representative for further information.

Manufacturer's warranty – DX tools

Hilti warrants that the tool supplied is free of defects in material and workmanship. This warranty is valid so long as the tool is operated and handled correctly, cleaned and serviced properly and in accordance with the Hilti Operating Instructions, and the technical system is maintained. This means that only original Hilti consumables, components and spare parts, or other products of equivalent quality, may be used in the tool.

This warranty provides the free-of-charge repair or replacement of defective parts only over the entire lifespan of the tool. Parts requiring repair or replacement as a result of normal wear and tear are not covered by this warranty.

Additional claims are excluded, unless stringent national rules prohibit such exclusion. In particular, Hilti is not obligated for direct, indirect, incidental or consequential damages, losses or expenses in connection with, or by reason of, the use of, or inability to use the tool for any purpose. Implied warranties of merchantability or fitness for a particular purpose are specifically excluded.

For repair or replacement, send tool or related parts immediately upon discovery of the defect to the address of the local Hilti marketing organization provided.

This constitutes Hilti's entire obligation with regard to warranty and supersedes all prior or contemporaneous comments and oral or written agreements concerning warranties.

Health and safety of the user

Noise information

The following table provides noise measurement information:

Powder-actuated tool

| | |
|----------------|---|
| Type: | DX 450 |
| Model: | Serial production |
| Caliber: | 6.8/11 yellow |
| Power setting: | 3 |
| Application: | Driving X-CR14 P8 fastener on 10 mm steel (390 MPa) |

Declared measured values of noise characteristics according to 2006/42/EC Machinery Directive in conjunction with E DIN EN 15895

| | | |
|--|------------------|-----------|
| Noise (power) level: | $L_{WA, 1s}^1$ | 111 dB(A) |
| Emission noise-pressure level in the work station: | $L_{pA, 1s}^2$ | 105 dB(A) |
| Peak sound pressure emission level: | $L_{pC, peak}^3$ | 137 dB(C) |

Operation and set-up conditions:

Set-up and operation of the pin driver in accordance with E DIN EN 15895-1 in the semi-anechoic test room of Müller-BBM GmbH. The ambient conditions in the test room conform to DIN EN ISO 3745.

Testing procedure:

Enveloping surface method in anechoic room on reflective surface area in accordance with E DIN EN 15895, DIN EN ISO 3745 and DIN EN ISO 11201.

NOTE: The noise emissions measured and the associated measurement uncertainty represent the upper limit for the noise values to be expected during the measurements. Variations in operating conditions may cause deviations from these emission values.

¹ ± 2 dB (A)

² ± 2 dB (A)

³ ± 2 dB (C)

Vibration

The declared total vibration value according to 2006/42/EC does not exceed 2.5 m/s².

Further information regarding the health and safety of the user can be found at the Hilti web site: www.hilti.com/hse

EC declaration of conformity (original)

| | |
|-----------------|----------------------|
| Designation: | Powder-actuated tool |
| Type: | DX 450 |
| Year of design: | 1976 |

We declare, on our sole responsibility, that this product complies with the following directives and standards: 2006/42/EC, 2011/65/EU.

Hilti Corporation, Feldkircherstrasse 100, FL-9494 Schaan



Norbert Wohlwend
Head of Quality & Processes Management
BU Direct Fastening
08/2012

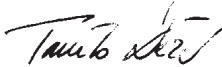

Tassilo Deinzer
Head BU Measuring Systems
BU Measuring Systems
08/2012

Technical documentation filed at:

Hilti Entwicklungsgesellschaft mbH
Zulassung Elektrowerkzeuge
Hiltistrasse 6
86916 Kaufering
Deutschland

Confirmation of CIP testing

The Hilti DX 450 has been system and type tested. As a result, the tool bears the PTB approval mark of square shape showing approval number **S 805**. In this way, Hilti guarantees compliance with the approved type.

Unacceptable/inadmissible defects, deficiencies, etc. that are determined during use of the tool must be reported to the manager responsible at the approval authority (PTB) and to the Office of the Permanent International Commission (C.I.P.).

Hilti Corporation
FL-9494 Schaan
Tel.: +423/234 21 11
Fax: +423/234 29 65
www.hilti.com

Printed: 24.03.2014 | Doc-Nr: PUB / 5125252 / 000 / 02

Hilti – registered trademark of Hilti Corp., Schaan W 2192 0214 20-Pos. 2 1 Printed in China © 2014
Right of technical and programme changes reserved S. E. & O.

311400 / A4